



# MAX1567 Evaluation Kit

## General Description

The MAX1567 evaluation kit (EV kit) is a fully assembled and tested circuit that accepts 2.8V to 4.2V input voltages and provides all the output voltages required for a typical digital still camera. The outputs consist of the main step-down output (3.3V), a step-down output (1.8V), a general-purpose 5V output, outputs for driving white LED backlighting, and outputs for charge-coupled device (CCD) and LCD bias. The EV kit comes with the MAX1567 installed, but can also be used to evaluate the MAX1566. For applications with a lower battery voltage, such as 2-AA battery applications, another version of the EV kit is available with the main output configured as a step-up converter (MAX1567SUMEVKIT).

## Features

- ◆ Up to 95% Efficient
- ◆ 2.8V to 4.2V Input Voltage Range
- ◆ Main Step-Down Output, 3.3V
- ◆ Step-Down Output, 1.8V
- ◆ 5V General-Purpose Output
- ◆ CCD and LCD Bias Outputs (+15V/-7.5V)
- ◆ Current-Regulated Output with Overvoltage Protection for White LED Backlighting
- ◆ 1 $\mu$ A Shutdown Mode
- ◆ Fully Assembled and Tested

## Ordering Information

PART	TEMP RANGE	IC PACKAGE
MAX1567EV KIT	0°C to +70°C	40 Thin QFN 6mm x 6mm

## Component List

DESIGNATION	QTY	DESCRIPTION
C1, C18	2	1 $\mu$ F $\pm$ 10%, 25V X7R ceramic capacitors (1206) TDK C3216X7R1E105K Taiyo Yuden TMK316BJ105KL or equivalent
C2	1	0.1 $\mu$ F $\pm$ 10%, 16V X7R ceramic capacitor (0603) TDK C1608X7R1C104K Taiyo Yuden EMK107BJ104KA or equivalent
C3	1	100pF $\pm$ 5%, 50V C0G ceramic capacitor (0603) TDK C1608C0G1H101J or equivalent
C4	1	6800pF $\pm$ 10%, 25V X7R ceramic capacitor (0402) TDK C1005X7R1E682K Taiyo Yuden TMK105BJ682KV or equivalent
C5, C7	2	3300pF $\pm$ 10%, 50V X7R ceramic capacitors (0402) TDK C1005X7R1H332K Taiyo Yuden UMK105BJ332KV or equivalent

DESIGNATION	QTY	DESCRIPTION
C6, C9	2	0.01 $\mu$ F $\pm$ 10%, 25V X7R ceramic capacitors (0402) TDK C1005X7R1E103K Taiyo Yuden TMK105BJ103KV or equivalent
C8	1	2200pF $\pm$ 10%, 50V X7R ceramic capacitor (0402) TDK C1005X7R1H222K Taiyo Yuden UMK105BJ222KV or equivalent
C10	1	47 $\mu$ F $\pm$ 20%, 6.3V X5R ceramic capacitor (1812) Taiyo Yuden JMK432BJ476MM or equivalent
C11	0	Not installed, capacitor (0805)
C12, C14	2	22 $\mu$ F $\pm$ 20%, 6.3V X5R ceramic capacitors (1210) Taiyo Yuden JMK325BJ226MM TDK C3225X5R0J226M
C13, C15, C16	3	10 $\mu$ F $\pm$ 20%, 6.3V X5R ceramic capacitors (0805) Taiyo Yuden JMK212BJ106MG TDK C2012X5R0J106M or equivalent

Evaluates: MAX1566/MAX1567

# MAX1567 Evaluation Kit

Evaluates: MAX1566/MAX1567

## Component List (continued)

DESIGNATION	QTY	DESCRIPTION
C17	1	4.7 $\mu$ F $\pm$ 20%, 10V X5R ceramic capacitor (0805) TDK C2012X5R1A475M or equivalent
C19	0	Not installed, capacitor (0805)
C20	0	Not installed, capacitor (1206)
D1, D6, D7, D10	4	Schottky diodes, 20V, 500mA (SOD-123) Central CMHSH5-2L
D2-D5	4	White LEDs Nichia NSCW215T
D8, D9	0	Not installed, diodes (SOD-123)
D11	1	Schottky diode, 2A, 30V (SMA) Nihon EC21QS03
JU1-JU6	6	3-pin headers
JU7, JU9, JU10, JU13, JU15	0	Not installed, jumpers cut here—short
JU8, JU11, JU12, JU14	0	Not installed, jumpers cut here—open
L1, L2	2	4.7 $\mu$ H inductors Sumida CDRH2D18-4R7
L3	1	22 $\mu$ H inductor TOKO A921CY-220M (D63LCB family)
L4	1	10 $\mu$ H inductor Sumida CDRH8D28-100
L5	1	10 $\mu$ H inductor Sumida CDRH5D28-100
L6	1	22 $\mu$ H inductor Sumida CDRH5D28-220
L7	0	Not installed, inductor

DESIGNATION	QTY	DESCRIPTION
N1, N2	2	n-channel MOSFETs (SOT23) Fairchild FDN361AN
N3	0	Not installed, n-channel MOSFET (SOT23)
P1	1	p-channel MOSFET (SOT23) Fairchild FDN360P
R1	1	1.1M $\Omega$ $\pm$ 5% resistor (0603)
R2, R12, R14, R16, R18, R20	6	90.9k $\Omega$ $\pm$ 1% resistors (0603)
R3	1	10 $\Omega$ $\pm$ 5% resistor (0603)
R4, R5	2	51k $\Omega$ $\pm$ 5% resistors (0603)
R6	1	33k $\Omega$ $\pm$ 5% resistor (0603)
R7	1	22k $\Omega$ $\pm$ 5% resistor (0603)
R8	1	60.4k $\Omega$ $\pm$ 1% resistor (0603)
R9, R22, R23	3	100k $\Omega$ $\pm$ 5% resistors (0603)
R10	1	16.2k $\Omega$ $\pm$ 5% resistor (0603)
R11, R21	2	1M $\Omega$ $\pm$ 1% resistors (0603)
R13	1	549k $\Omega$ $\pm$ 1% resistor (0603)
R15	1	274k $\Omega$ $\pm$ 1% resistor (0603)
R17	1	150k $\Omega$ $\pm$ 1% resistor (0603)
R19	1	40.2k $\Omega$ $\pm$ 1% resistor (0603)
R24-R29	0	Not installed, resistors (1206)
R30, R31	0	Not installed, resistors (0603)
T1	0	Not installed, transformer
U1	1	MAX1567ETL (40-pin thin QFN 6mm x 6mm)
None	6	Shunts, 2 position
None	1	MAX1567EVKIT PC board

# MAX1567 Evaluation Kit

Evaluates: MAX1566/MAX1567

## Quick Start

### Recommended Equipment

- Power supply capable of supplying 2.8V to 4.2V at 2A
- Voltmeter
- Load resistors or electronic loads

### Procedure

Follow the steps below to verify operation of the MAX1567 EV kit:

- 1) Preset the power supply to between 2.8V and 4.2V.
- 2) Turn off the power supply. **Do not turn on the power supply until all connections are completed.**
- 3) Connect the power-supply positive lead to the pad on the EV kit board labeled BATT.
- 4) Connect the power-supply ground lead to the pad on the EV kit board labeled GND.
- 5) Connect loads from the outputs VM, VSD, OUT1A, and OUT2 to GND. See Table 1 for maximum load currents.
- 6) Short pins 2-3 of JU1 to enable VSU.
- 7) Short pins 1-2 of JU2–JU6 to disable all other outputs.
- 8) Turn on the power supply.
- 9) Verify the VSU voltage (5V) using a voltmeter.
- 10) If desired, connect a load from VSU to GND.
- 11) To verify other outputs, move jumpers JU2–JU6 to short pins 2 and 3 to enable corresponding outputs, and verify the output voltage with a voltmeter (see Table 1).

## Detailed Description

### Step-Up Output (VSU)

The main step-up output (VSU) powers the internal circuitry of the MAX1567 and must reach its regulation voltage (5V) before any other output can turn on. To enable VSU, short pins 2-3 of jumper JU1. When jumper JU1 is on pins 1-2, all outputs shut down and the IC is in low-current shutdown mode.

### Short-Circuit Flag (SCF)

SCF is an open-drain output that is high impedance when overload protection occurs. Under normal operation SCF pulls low. In the default configuration, there is a 100kΩ pullup resistor (R23) from SCF to the input of the main converter.

**Table 1. Output Voltages and Maximum Currents**

OUTPUT	VOLTAGE (V)	MAXIMUM CURRENT (mA)
VSU	5	500 (Note 1)
VM	3.3	600
VSD	1.8	350
OUT1A	15	40
OUT2	-7.5	-80
LEDOUT+ to LEDOUT-	16 max (Note 2)	20

**Note 1:** If VSU and VM are operating, subtract about 70% of the VM load current from the maximum load capability of VSU.

**Note 2:** The LED outputs are current regulated to 20mA with overvoltage protection set to 16V.

### Main Step-Down Output (VM)

The main step-down output is set to 3.3V. To enable VM, short pins 2-3 of jumper JU2. To shut down VM, short pins 1-2 of JU2.

### Step-Down Output (VSD)

The step-down output (VSD) is set to 1.8V. To enable VSD, short pins 2-3 of jumper JU3. To shut down OUTSD, short pins 1-2 of JU3.

### Step-Down OK (SDOK)

The step-down OK output (SDOK) is an open-drain output that is pulled low when the step-down converter has completed soft-start. For more details on SDOK, refer to the MAX1567 data sheet.

### Auxiliary Output 1 OK (AUX1OK)

AUX1OK is an open-drain output that goes low when OUT1 has successfully completed soft-start. AUX1OK goes high impedance in shutdown, overload, and thermal limit.

### CCD/LCD Bias Outputs (OUT1A, OUT1B)

The output OUT1A provides a regulated +15V output. To enable OUT1A, short pins 2-3 of JU5. To turn off OUT1A, short pins 1-2 of JU5. In the standard configuration, OUT1A and OUT2 provide the +15V and -7.5V bias voltages for CCD and LCD. OUT1B is not used in the standard configuration of the EV kit.

Outputs OUT1A and OUT1B can be configured to use a flyback transformer to provide both the +15V (OUT1A) and -7.5V (OUT1B) necessary for CCD and LCD bias. This is useful when using the MAX1566 where OUT2 is configured as a boost converter. See the *Flyback Transformer Configuration for OUT1A/OUT1B* section.

# MAX1567 Evaluation Kit

## Inverter Output (OUT2)

OUT2 is a regulated -7.5V output. To enable OUT2, connect pins 2-3 of jumper JU6. To shut down OUT2, connect pins 1-2 of JU6.

OUT2 can also be configured as a boost output when evaluating the MAX1566. See the *Evaluating the MAX1566* section.

## LED Outputs (OUT3+, OUT3-)

Outputs OUT3+ and OUT3- are for driving a series of white LEDs for backlighting. The EV kit comes with four surface-mount white LEDs installed and is configured to drive the LEDs at a regulated 20mA. To protect against an open LED string, the overvoltage protection sets the maximum output voltage to 16V.

To evaluate with fewer than four LEDs, short the pads of the unused LEDs. To use LEDs other than the ones mounted on the board, break the string by removing one of the LEDs on the board, then connect a series array consisting of two to six white LEDs in series to the OUT3+ and OUT3- outputs. The anode side of the array connects to OUT3+ and the cathode side connects to OUT3-. To enable the LED outputs, short pins 2-3 of JU4. To turn the LED outputs off, short pins 1-2 of JU4. To adjust the LED brightness or overvoltage protection, see the *Adjusting the LED Brightness* section.

## Customizing the MAX1567 Evaluation Kit

### Adjusting the Step-Up Output (VSU)

The step-up output (VSU) is adjustable from 2.7V to 5.5V using the following procedure:

- 1) Select a value for R16 between 10kΩ and 100kΩ.
- 2) Solve for R15 using:

$$R15 = R16 \times \left( \frac{V_{VSU}}{1.25V} - 1 \right)$$

- 3) Install resistors R15 and R16.

Note that if the input voltage is greater than what VSU is set to, then VSU will rise above its regulation voltage.

### Configuring the Main Step-Down Output (VM)

The input to the main step-down converter is connected to VSU by default. To change this connection to BATT, cut the trace shorting JU15 and short JU14.

The main step-down output (VM) is adjustable from 1.25V to VSU using the following procedure:

- 1) Select a value for R18 between 10kΩ and 100kΩ.
- 2) Solve for R17 using:

$$R17 = R18 \times \left( \frac{V_{VM}}{1.25V} - 1 \right)$$

- 3) Install resistors R17 and R18.

**Table 2. Jumper Functions**

JUMPER	SHORT PINS 1-2	SHORT PINS 2-3
JU1	All outputs are shut down	VSU enabled
JU2	VM shut down	VM enabled
JU3	VSD shut down	VSD enabled
JU4	LEDs (OUT3+/OUT3-) shut down	LEDs (OUT3+/OUT3-) enabled
JU5	OUT1 shut down	OUT1 enabled
JU6	OUT2 shut down	OUT2 enabled

**Table 3. PC Board Jumper Functions**

JUMPER	DEFAULT	FUNCTION
JU7	SHORT	Selects the input power for the OUT2 converter. Short only one of these jumpers. Short JU7 to connect the OUT2 input power to BATT, or short JU8 to connect to VSU.
JU8	OPEN	
JU9	SHORT	Connects the ground planes together. This must remain shorted for proper circuit operation.
JU10	SHORT	Selects the input power for the step-down converter. Short only one of these jumpers. Short JU10 to connect the step-down input power to BATT, short JU11 for VSU, or short JU12 for VM.
JU11	OPEN	
JU12	OPEN	
JU13	SHORT	Selects topology for OUT1A/OUT1B. Short for OUT1A step-up, or open for OUT1A/OUT1B transformer flyback.
JU14	OPEN	Selects the input power for the main step-down converter. Short only one of these jumpers. Short JU14 to connect the input of VM to BATT, or short JU15 for VSU.
JU15	SHORT	

# MAX1567 Evaluation Kit

## Configuring the Step-Down Output (VSD)

The input to the step-down converter (PVSD) on the EV kit comes connected to BATT, but the connection can be changed to either VM or VSU. To use VM as the input to the step-down converter, cut the trace shorting JU10 and short the pads of JU12. To use VSU as the input to the step-down converter, cut the trace shorting JU10, and short the pads of JU11. Make sure one and only one of JU10, JU11, and JU12 is shorted.

The step-down output voltage (VSD) is adjustable from 1.25V to VBATT using the following procedure:

- 1) Select a value for R20 between 10k $\Omega$  and 100k $\Omega$ .
- 2) Solve for R19 using:

$$R19 = R20 \times \left( \frac{V_{VSD}}{1.25V} - 1 \right)$$

- 3) Install resistors R19 and R20.

## Adjusting the OUT1A Voltage

OUT1A can be set to a voltage above 1.25V. The upper limit depends on the ratings of the external components. Note that if the input voltage is greater than what OUT1A is set to, then OUT1A will rise above its regulation voltage. Use the following procedure to set V<sub>OUT1A</sub>:

- 1) Select a value for R12 between 10k $\Omega$  and 100k $\Omega$ .
- 2) Solve for R11 using:

$$R11 = R12 \times \left( \frac{V_{OUT1A}}{1.25V} - 1 \right)$$

- 3) Install resistors R11 and R12.

## Configuring the Inverting Output (OUT2)

The input to the inverter is normally connected to BATT. To change this connection to VSU, cut the trace shorting JU7 and short the pads of JU8. Note that the lower limit of inverter operation, when powered from BATT, depends on the external p-channel MOSFET threshold voltage.

To adjust the OUT2 voltage, use the following procedure:

- 1) Select a value for R13 between 10k $\Omega$  and 100k $\Omega$ .
- 2) Solve for R14 using:

$$R13 = R14 \times \left( - \frac{V_{OUT2}}{1.25V} \right)$$

- 3) Install resistors R13 and R14.

## Adjusting the LED Brightness

Resistor R3 sets the regulation current of the LEDs as follows:

$$R3 = \frac{0.2V}{I_{LED}}$$

The overvoltage-protection threshold for the LEDs is also adjustable. To ensure the LEDs are current regulated, this threshold (V<sub>OVP</sub>) must be set higher than the maximum forward-voltage drop of the LED string. V<sub>OVP</sub> should be set lower than the maximum voltage ratings of the capacitor, diode, and MOSFET (C1, D1, and N1) used in the LED driver circuit. Use the following procedure to set the overvoltage protection:

- 1) Select a value for R1 between 10k $\Omega$  and 100k $\Omega$ .
- 2) Solve for R2 using:

$$R1 = R2 \times \left( \frac{V_{OVP}}{1.25V} - 1 \right)$$

- 3) Install resistors R1 and R2.

## Changing the Switching Frequency

The switching frequency of the MAX1567 is adjustable. Typically, frequencies from 400kHz to 500kHz provide a good compromise between efficiency and component size. To change the frequency, replace C3 and R4. Refer to the MAX1566/MAX1567 data sheet for information on selecting values for these components.

## Evaluating the MAX1566

To evaluate the MAX1566, first carefully remove U1 and replace it with the MAX1566. Free samples of the MAX1566 can be obtained from Maxim. The MAX1566 requires that OUT2 be configured as a boost converter.

## Configuring OUT2 as a Boost Converter

To configure OUT2 as a boost converter, remove components C17, R13, R14, D7, and P1. Then add components C19, R30, R31, D8, L7, and N3. Refer to the MAX1566/MAX1567 data sheet for information on component selection. Table 4 shows typical components for generating +15V at up to 20mA.

## Flyback Transformer Configuration for OUT1A/OUT1B

OUT1 can be configured to provide two outputs using a transformer. This is usually done to generate CCD/LCD bias when using the MAX1566. To use a transformer, remove L2 and cut the trace shorting JU13. Install the transformer on the footprint (T1) that overlaps L2 and JU13. Refer to the MAX1566/MAX1567 data sheet for details on component selection. Table 5 shows typical

# MAX1567 Evaluation Kit

Evaluates: MAX1566/MAX1567

**Table 4. Typical Components for OUT2 Boost Circuit**

DESIGNATION	QTY	DESCRIPTION
C19	1	1 $\mu$ F $\pm$ 10%, 25V X7R ceramic capacitor (0805) TDK C2012X7R1E105K
R30	1	1M $\Omega$ $\pm$ 1% resistor (0603)
R31	1	90.9k $\Omega$ $\pm$ 1% resistor (0603)
L7	1	1.5 $\mu$ H inductor Sumida CDRH3D16-1R5
D8	1	Schottky diode, 40V, 500mA (SOD-123) Central CMHSH5-4
N3	1	n-channel MOSFET (SOT23) Fairchild FDN337N

**Table 5. Typical Components for OUT1A/OUT1B Transformer Circuit**

DESIGNATION	QTY	DESCRIPTION
C18, C20	2	1 $\mu$ F $\pm$ 10%, 25V X7R ceramic capacitors (1206) TDK C3216X7R1E105K
R11	1	1M $\Omega$ $\pm$ 1% resistor (0603)
R12	1	90.9k $\Omega$ $\pm$ 1% resistor (0603)
T1	1	Transformer TDK LDT565630T-MX1
D6	1	Schottky diode, 40V, 500mA (SOD-123) Central CMHSH5-4
D9	1	Schottky diode, 20V, 500mA (SOD-123) Central CMHSH5-2L
N2	1	n-channel MOSFET (SOT23) Fairchild FDN337N

## Component Suppliers

SUPPLIER	PHONE	WEBSITE
Central Semiconductor	631-435-1110	www.centrasemi.com
Fairchild Semiconductor	408-721-2181	www.fairchildsemi.com
International Rectifier	310-322-3331	www.irf.com
Kamaya	260-489-1533	www.kamaya.com
Murata	814-237-1431	www.murata.com
Panasonic	714-373-7939	www.panasonic.com
Sumida	847-956-0666	www.sumida.com
Taiyo Yuden	408-573-4150	www.t-yuden.com
TDK	847-803-6100	www.component.tdk.com
TOKO	847-297-0070	www.toko.com
Vishay	402-563-6866	www.vishay.com

**Note:** Indicate you are using the MAX1567 when contacting these suppliers.



# MAX1567 Evaluation Kit

Evaluates: MAX1566/MAX1567

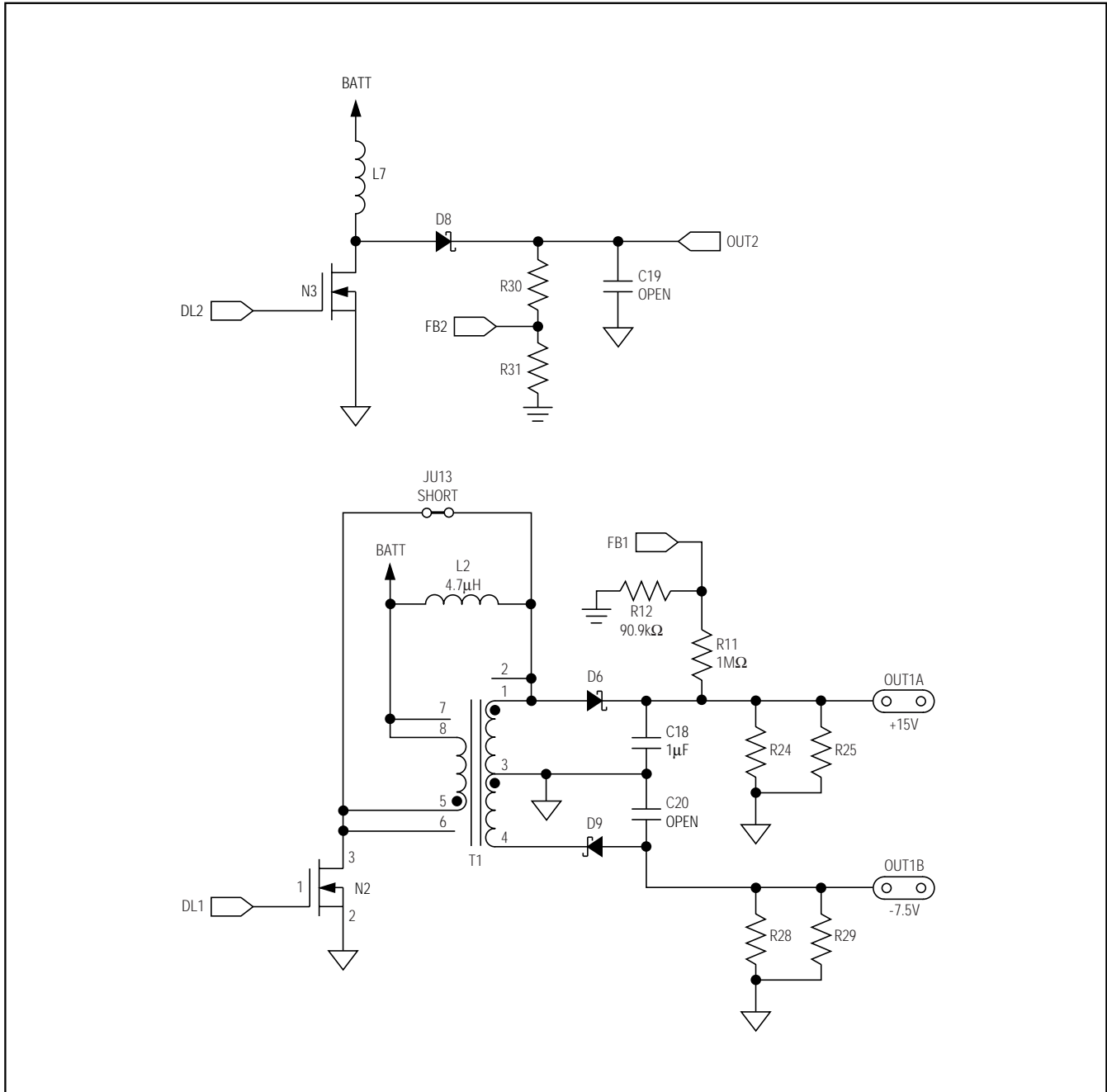

Figure 2. MAX1567 EV Kit Schematic (Sheet 2 of 2)



# MAX1567 Evaluation Kit

Evaluates: MAX1566/MAX1567

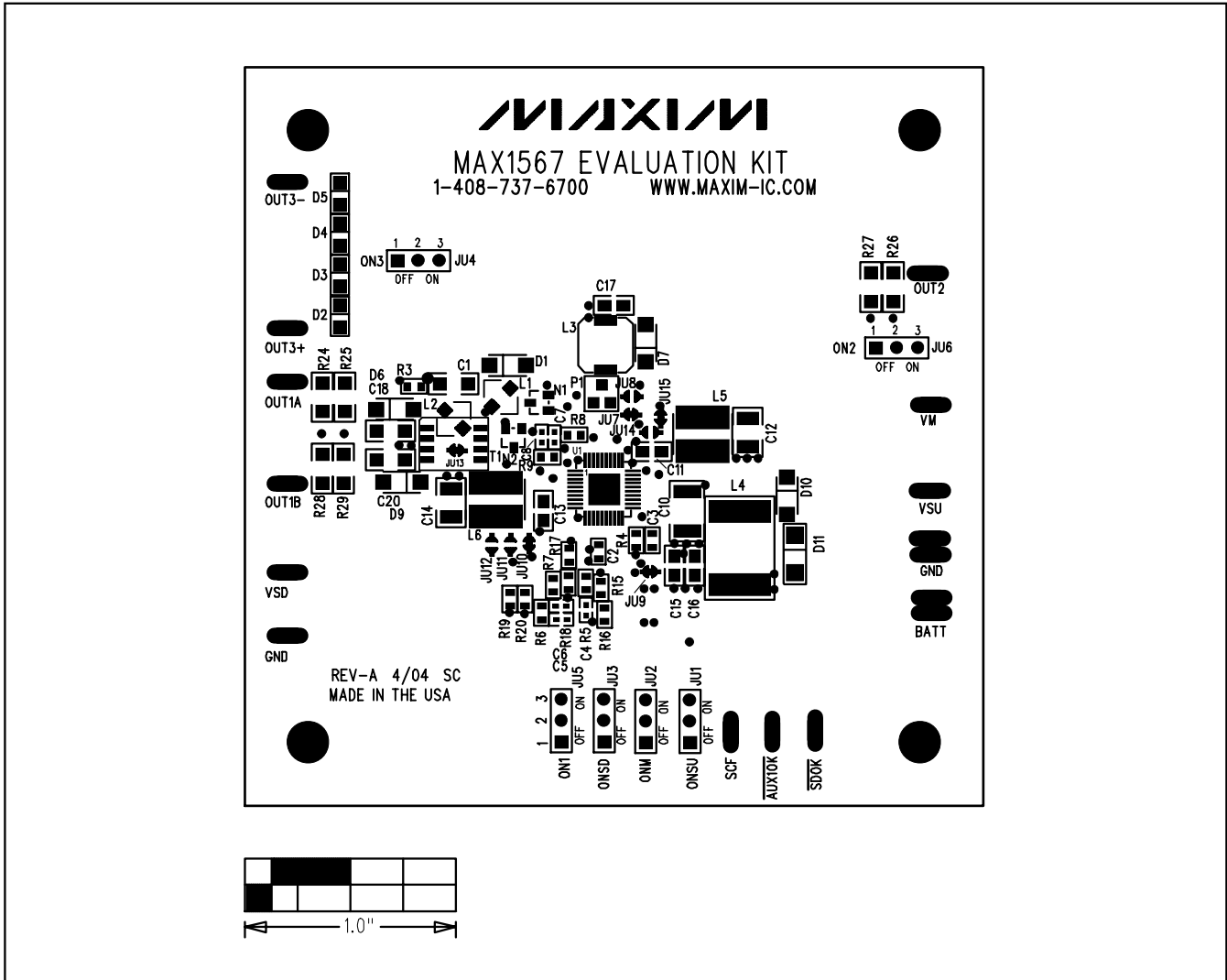

Figure 3. MAX1567 EV Kit Component Placement—Component Side

# MAX1567 Evaluation Kit

Evaluates: MAX1566/MAX1567

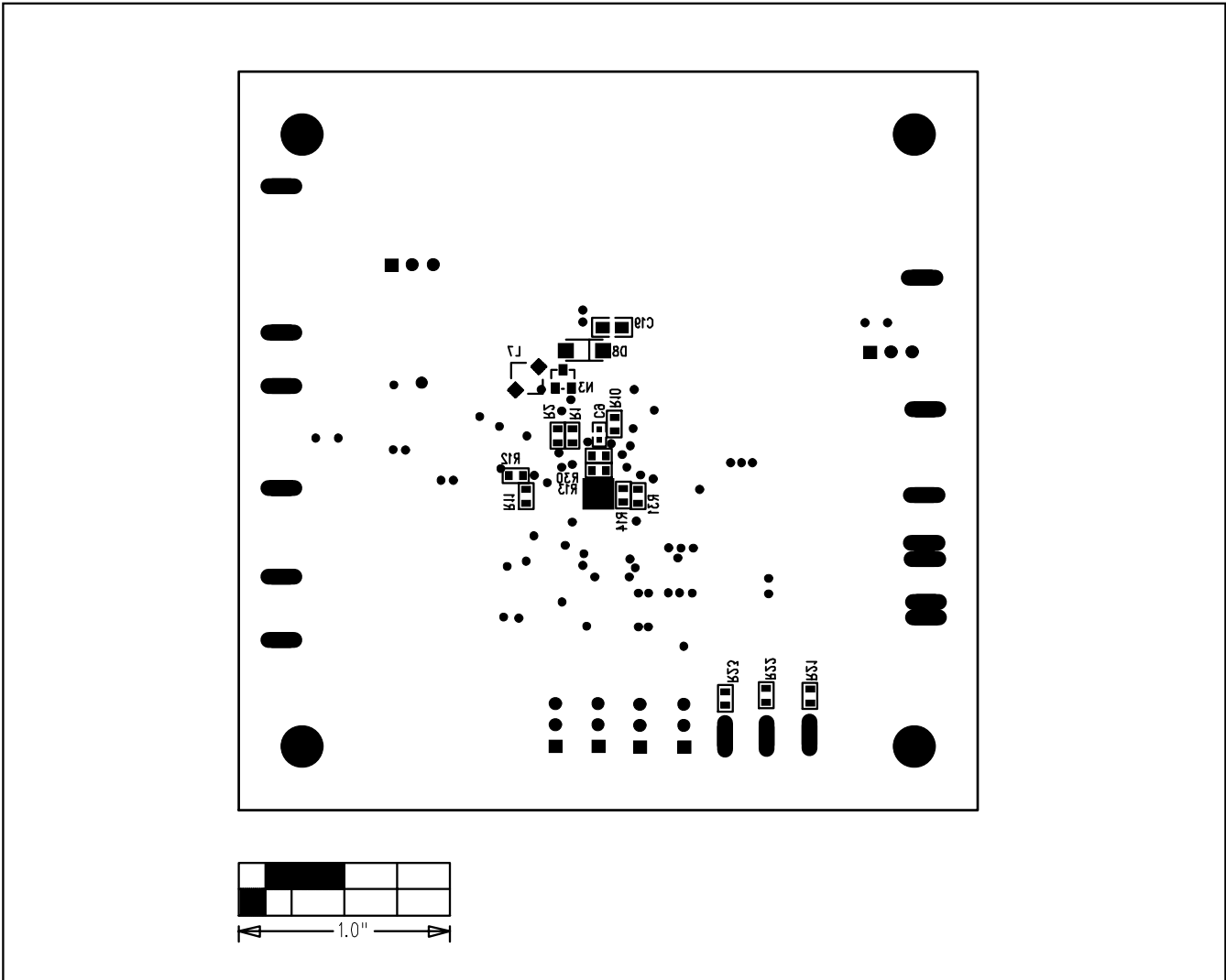

Figure 4. MAX1567 EV Kit Component Placement—Solder Side

# MAX1567 Evaluation Kit

Evaluates: MAX1566/MAX1567

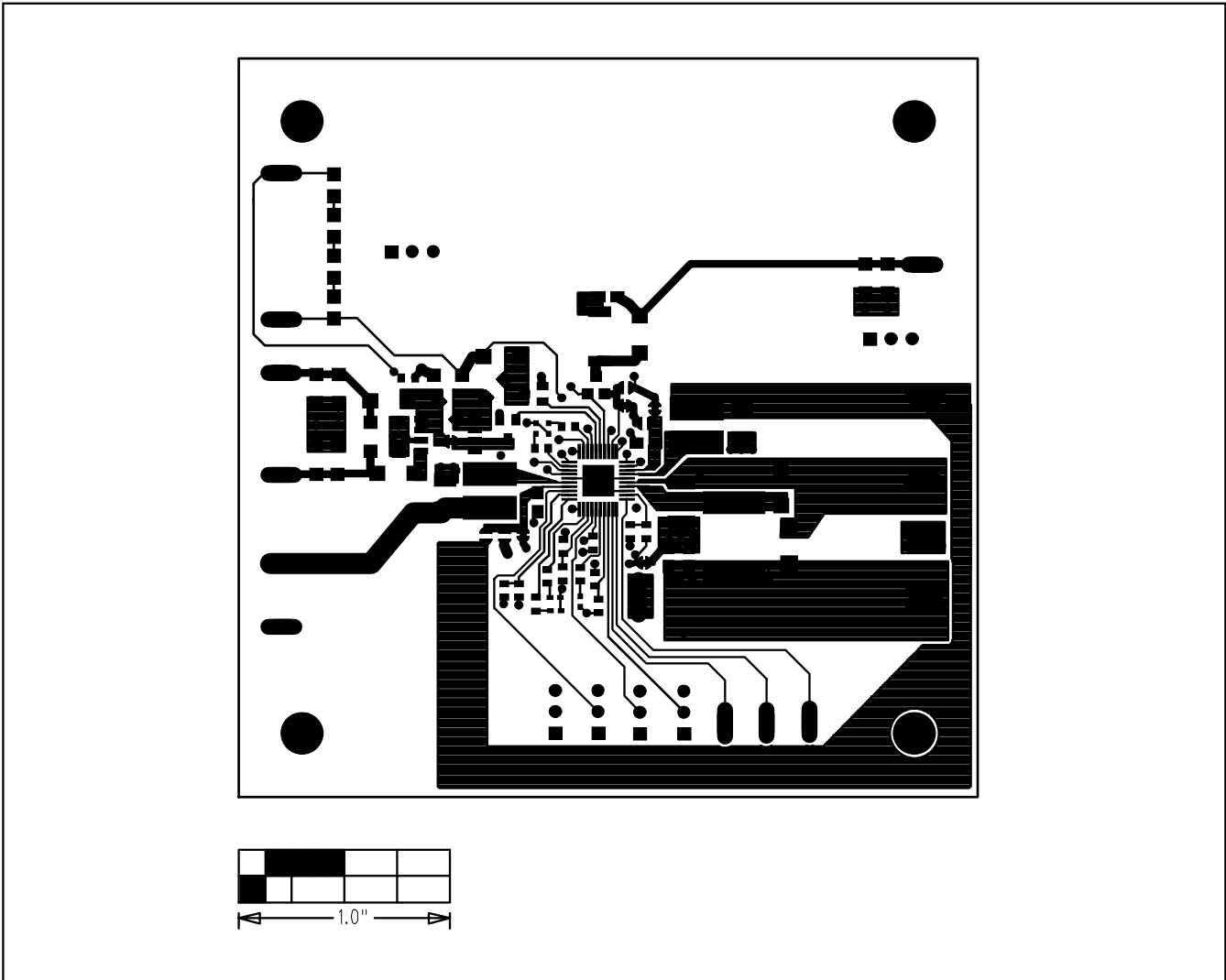

Figure 5. MAX1567 EV Kit PC Board Layout—Component Side

# MAX1567 Evaluation Kit

Evaluates: MAX1566/MAX1567

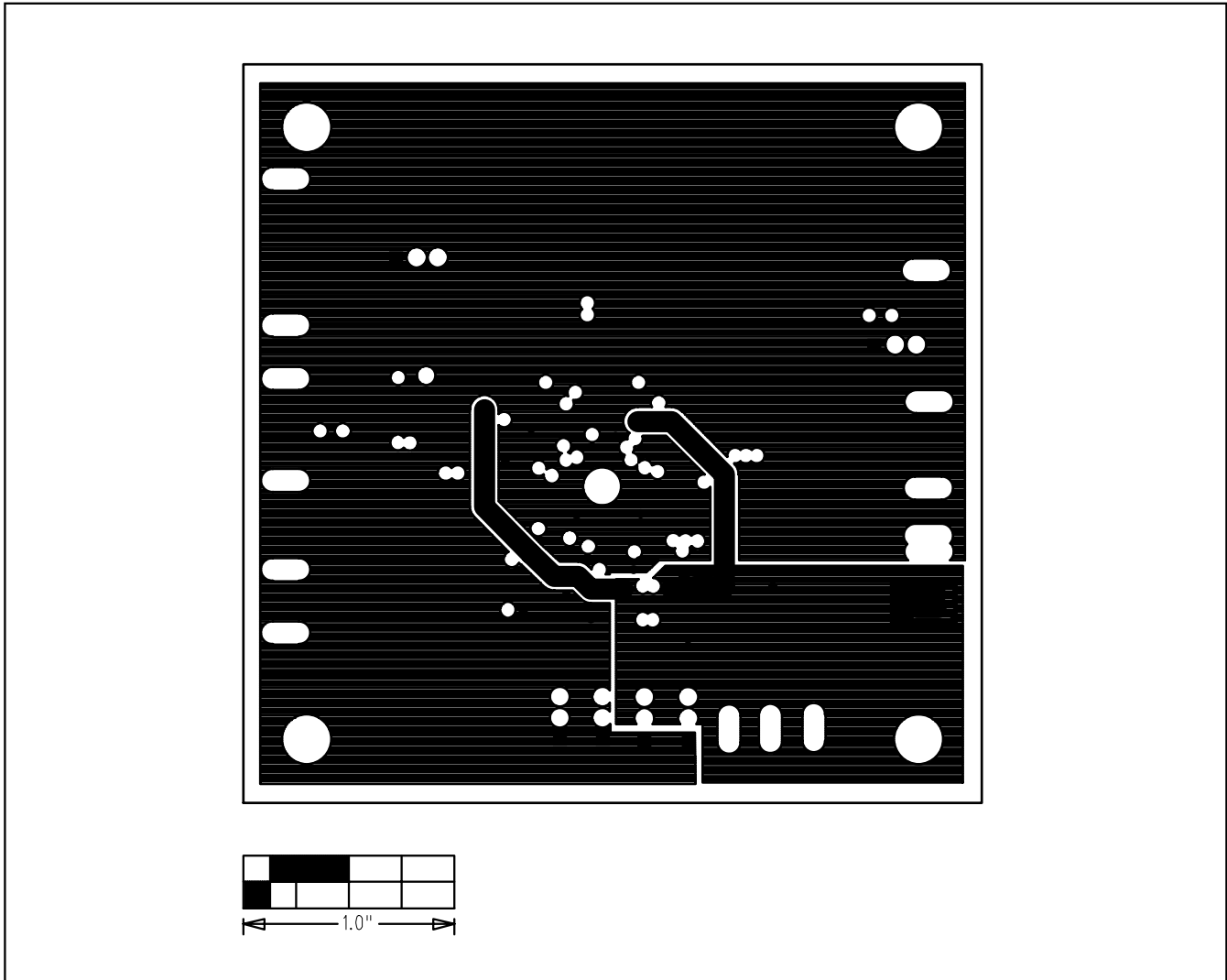

Figure 6. MAX1567 EV Kit PC Board Layout—Inner Layer 2

# MAX1567 Evaluation Kit

Evaluates: MAX1566/MAX1567

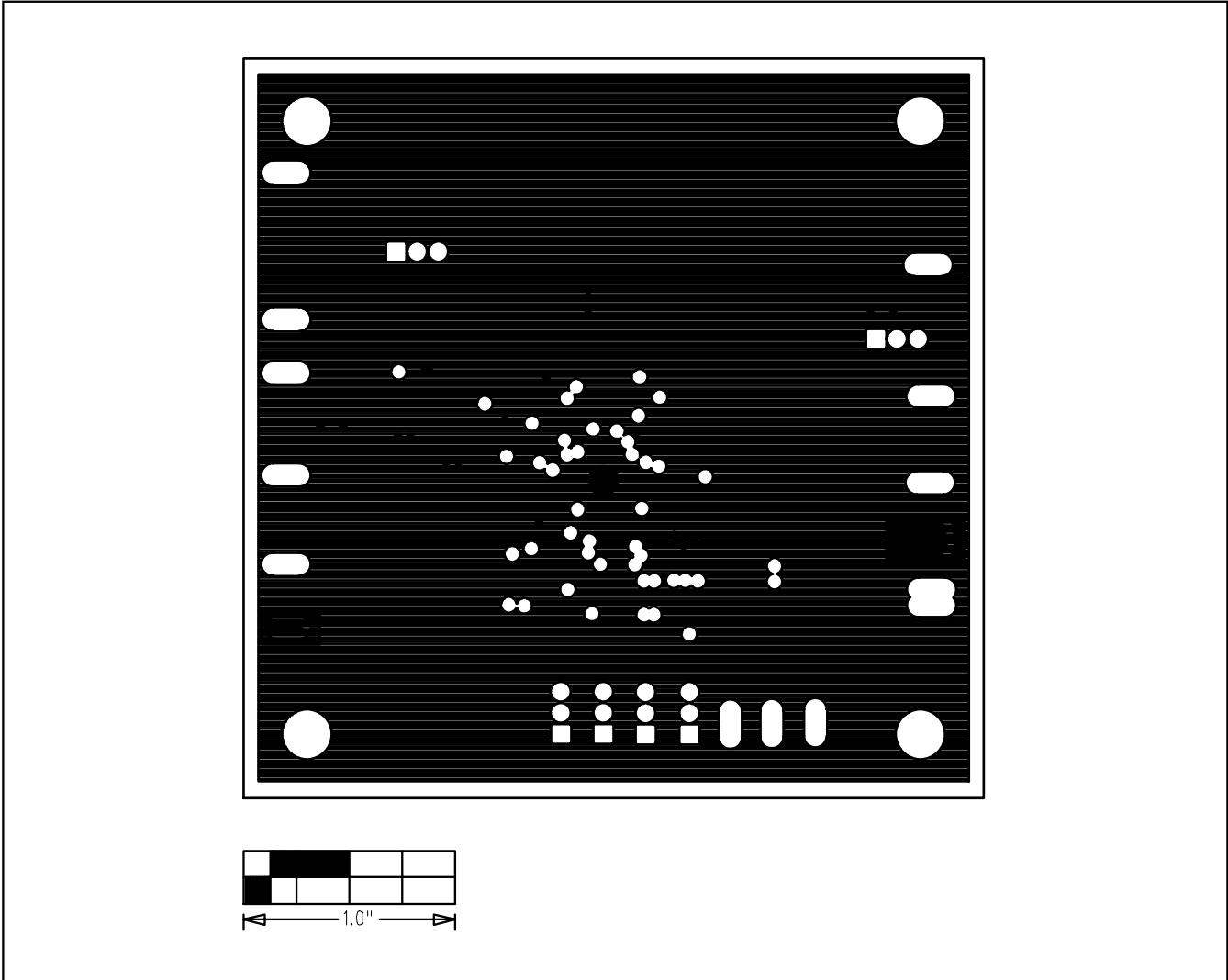

Figure 7. MAX1567 EV Kit PC Board Layout—Inner Layer 3

# MAX1567 Evaluation Kit

Evaluates: MAX1566/MAX1567

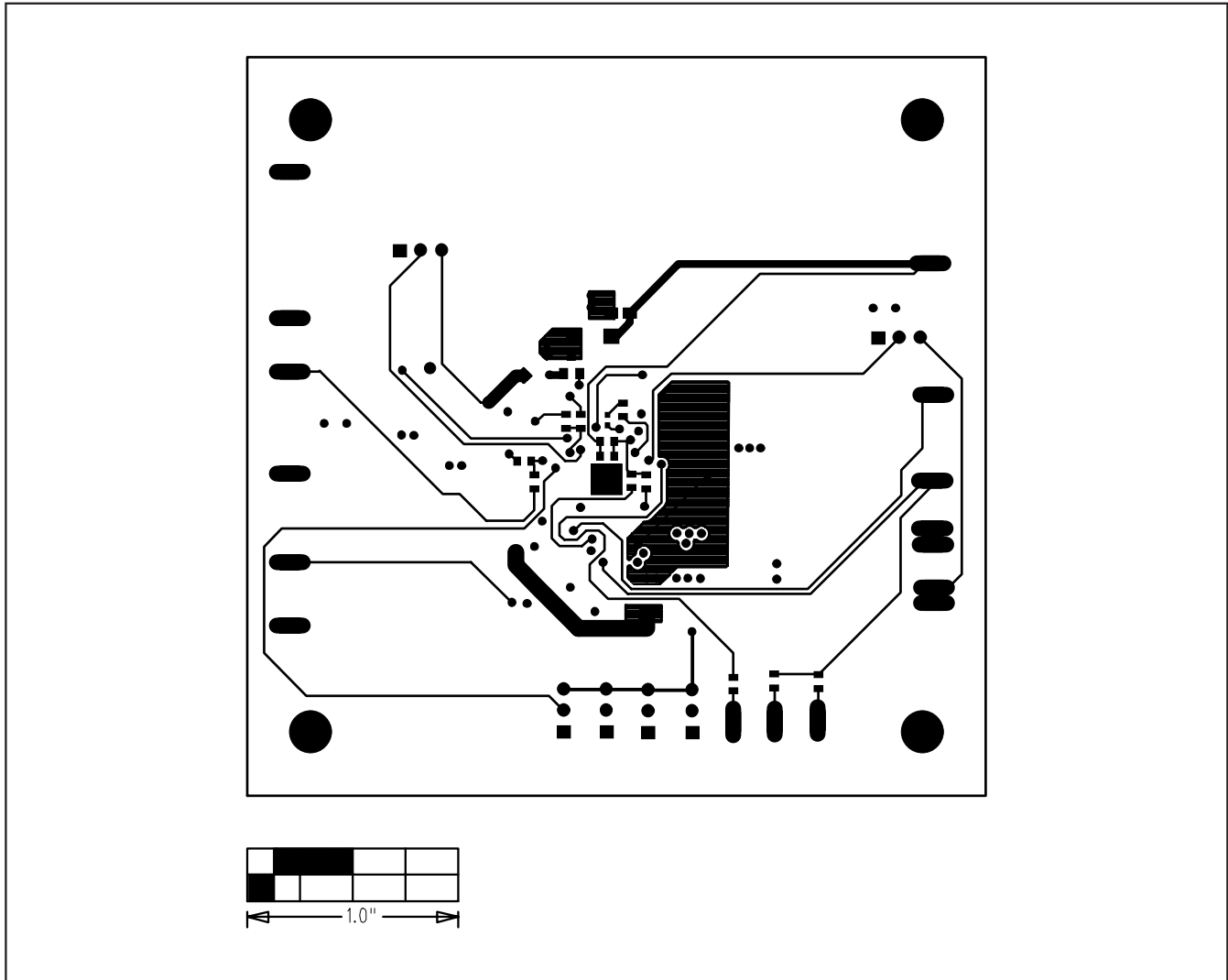

Figure 8. MAX1567 EV Kit PC Board Layout—Solder Side

Maxim cannot assume responsibility for use of any circuitry other than circuitry entirely embodied in a Maxim product. No circuit patent licenses are implied. Maxim reserves the right to change the circuitry and specifications without notice at any time.

14 \_\_\_\_\_ Maxim Integrated Products, 120 San Gabriel Drive, Sunnyvale, CA 94086 408-737-7600

© 2004 Maxim Integrated Products

Printed USA

**MAXIM** is a registered trademark of Maxim Integrated Products.